

MUSIC
with Michal

“**CELEBRATE!
MUSIC!
CACA CAW!
MUSIC!
WE IN!**”

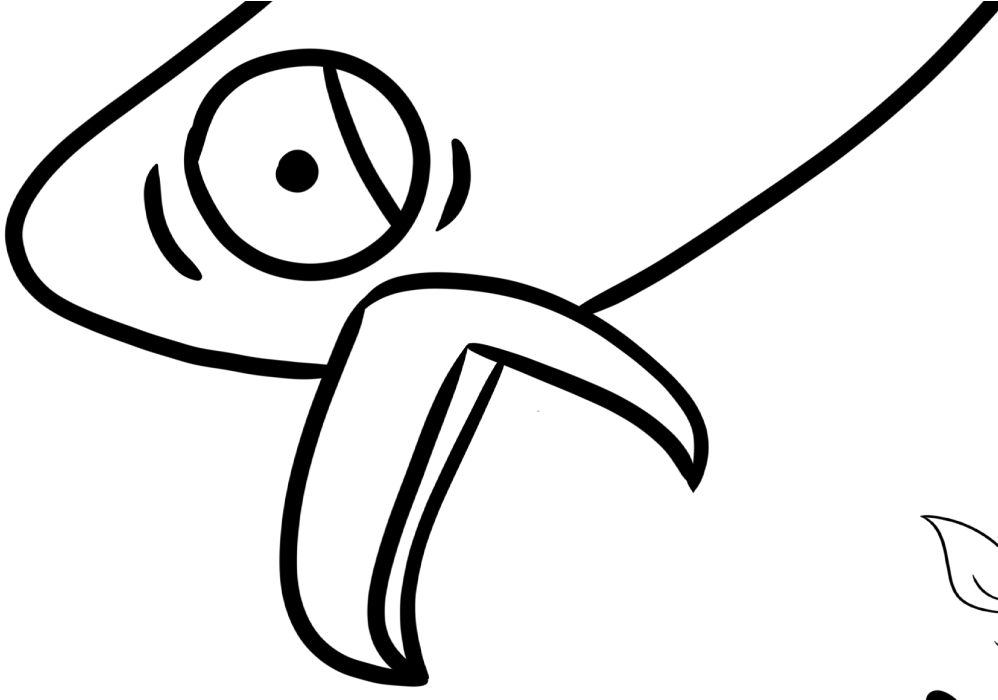

FAIRIES

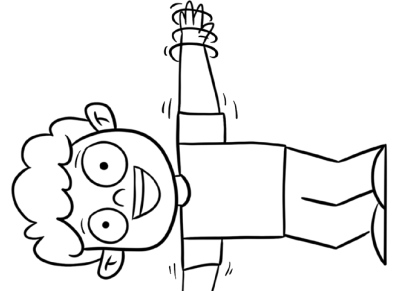
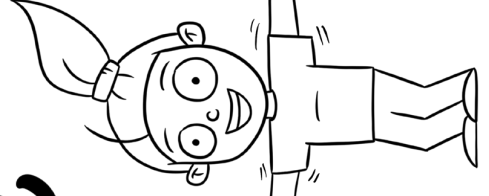
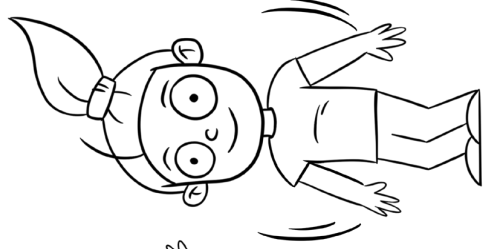
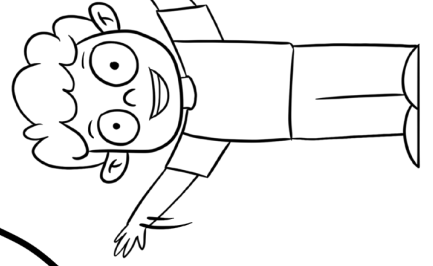
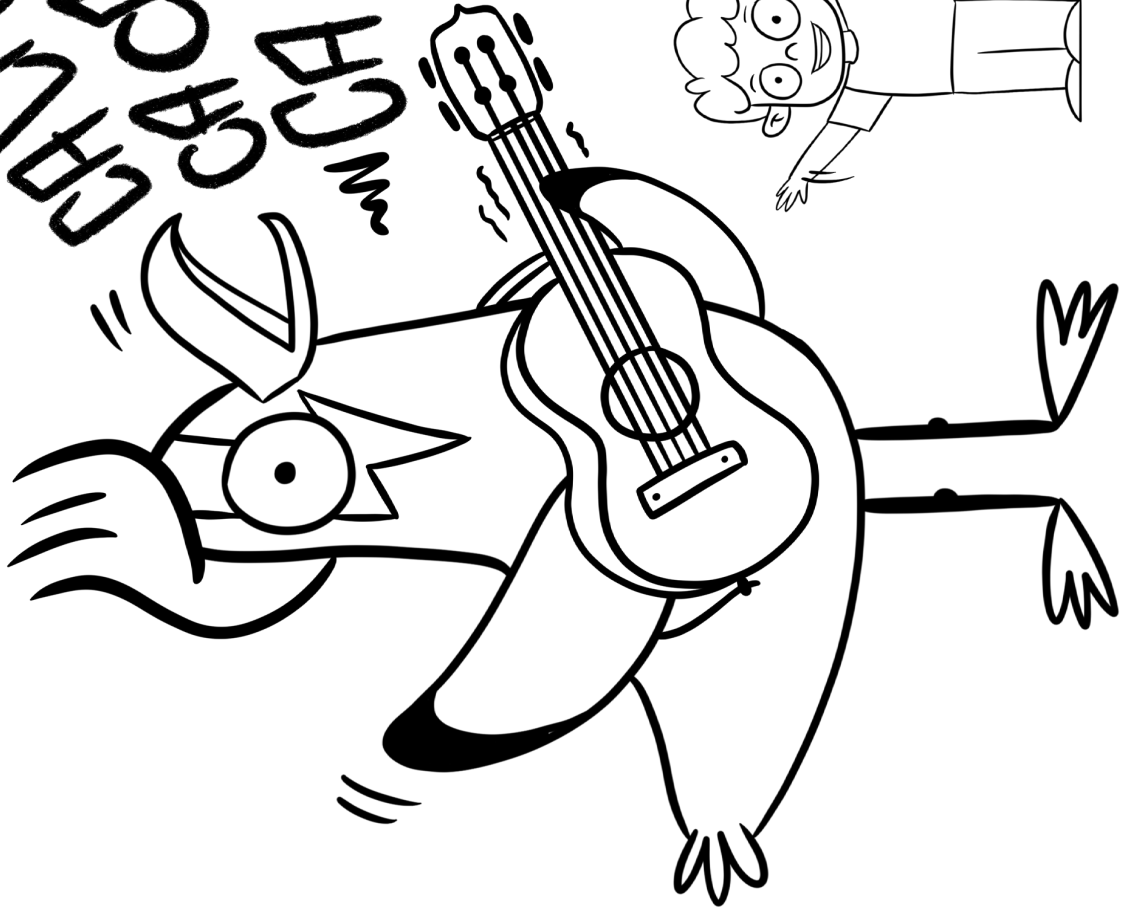

MUSIC
with Michal

Name: _____

Age: _____

BUNNIES

IN THE BATH

(COUNTING SONG)



1, 2, 3, 4, 5

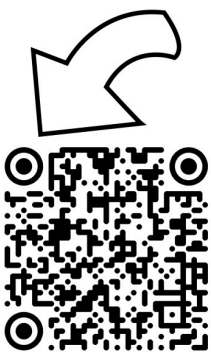

Get a
free
chord
chart!

claudia
robin
gunn

LISTEN

LINK!



Name: _____

Age: _____

ROUND ROBIN

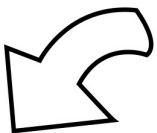

Get a
free
chord
chart!

claudia
robin
gunn

LISTEN
LINK!



SUZY CATO and friends

Name.....

Age.....

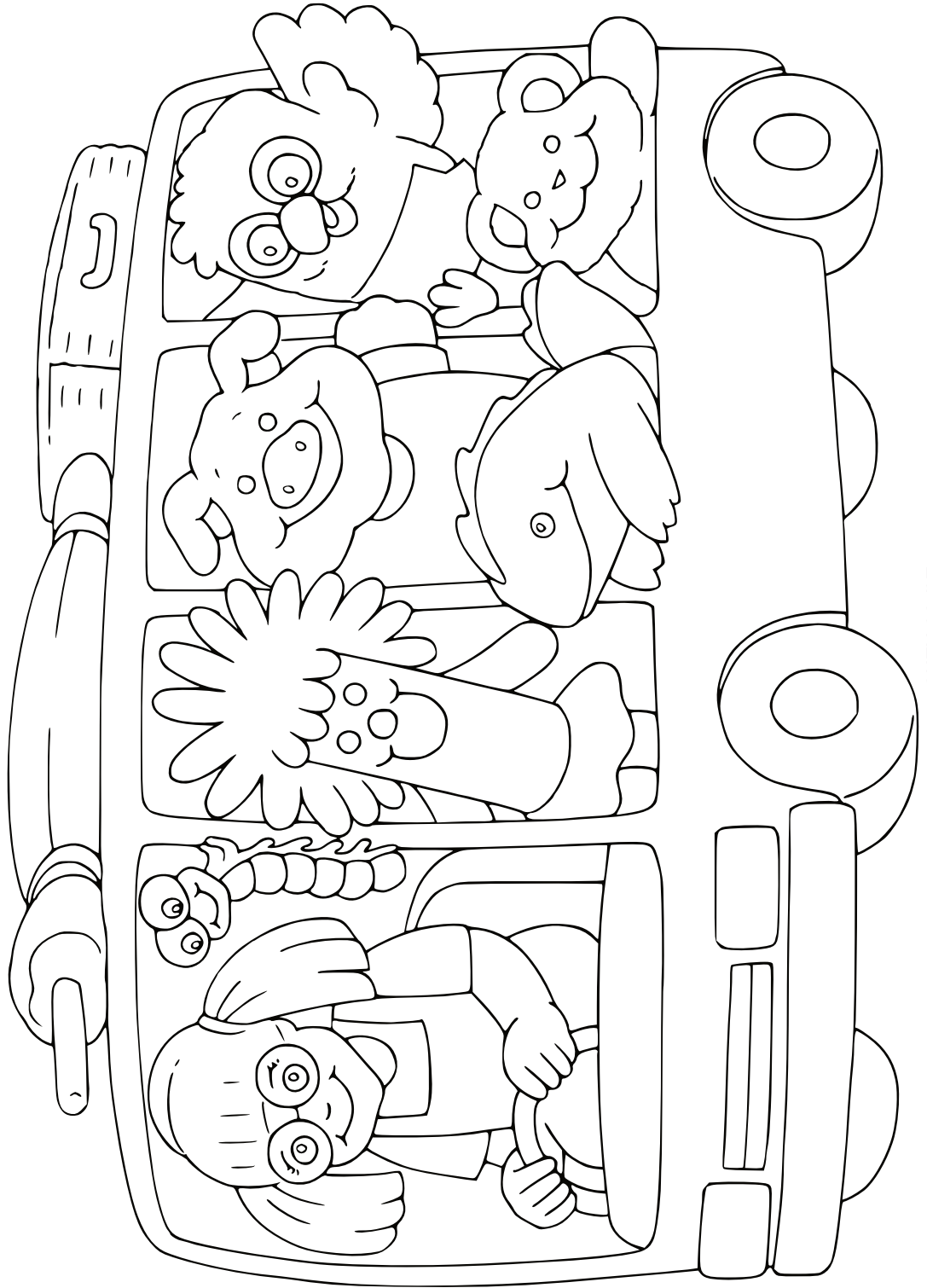

Suzy's bubble of fun

MUSICAL INSTRUMENTS

Musical instruments are great fun, but the spoon and saucepan can be a little hard on the ears! Here are some quieter suggestions that are also fun to make.

- ☆ Old plastic ice-cream containers make great drums (and they are quieter than saucepans). Several can be set up in a circle to make a drum kit. Or you can attach a ribbon or cord through two holes cut in the container with a sharp knife to make a strap that can go around the child's neck. Great for pretending you're in a marching band!
- ☆ Trumpets are easily made with a cone of paper rolled into shape and taped into place - or by cutting an old plastic milk container in half.
- ☆ A piece of wood with three nails hammered in at both ends and three rubber bands stretched between them can make a pretty good guitar.
- ☆ Shakers are a very easy musical instrument to make and the options are endless. Any old plastic container or bottle with a good fitting lid will do the job. You can fill shakers with tiny pebbles or something from the kitchen cupboard like dried beans or rice.

☆ Of course you can decorate your music instruments any way you like

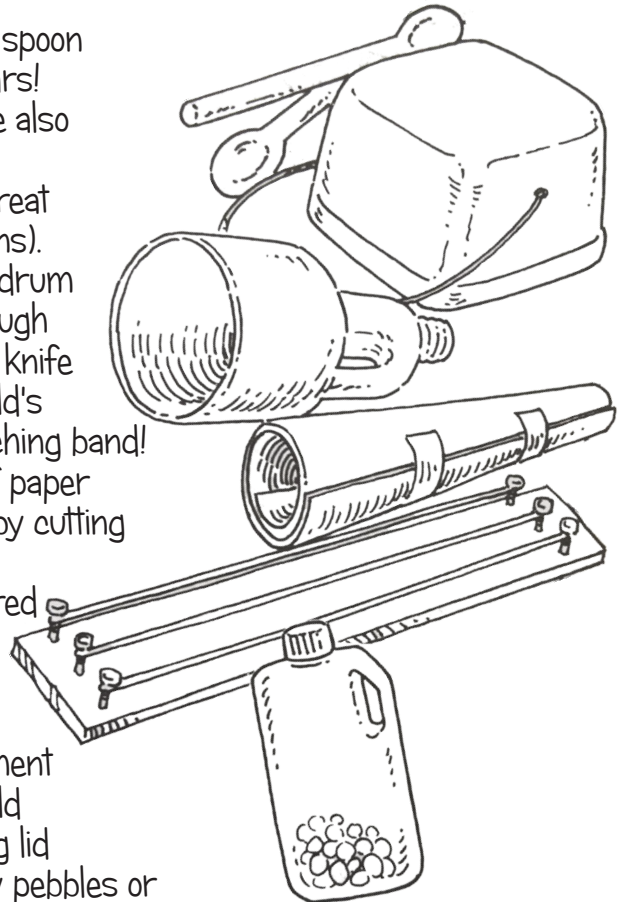

Originally published in Suzy Cato and friends activity book 1996

MAKE MUSIC

JUNE 21

Make Music Day is a global phenomenon embraced by over 1000 cities worldwide. Join us to celebrate music as part of an international event with its heart and soul in our local communities!

Make Music Day Events can happen in conventional and unconventional spaces. From retail and hospitality premises to community centres, public spaces or even your front porch! Any musician – amateur or professional, young or old – is invited to take part. Likewise businesses, councils, neighbours, schools, churches and organisations of all shapes and sizes can sign up to offer their spaces as a venue. All of Aotearoa is encouraged to participate reconnect with neighbours & communities and dive into your creativity.

HOW CAN I GET INVOLVED?

Getting involved in Make Music Day is super simple!

If you want to play music – register as performer. If you want to offer a place for people to play – register as a venue. Our innovative match-making database connects performers with venues, and venues with performers. If you already have an event set up with performers & venues confirmed – register the event so others can find out about it. Registrations are open now!

Make Music Day promises to be a day of joy, creativity and community spirit.
For more information and updates on Make Music Day, visit

MAKEMUSICDAY.ORG/ NZ



GLOBAL PARTNER



AUCKLAND
CITY OF MUSIC
TĀMAKI MAKĀURAU
PĀ PUORO



MAKE
MUSIC

JUNE 21

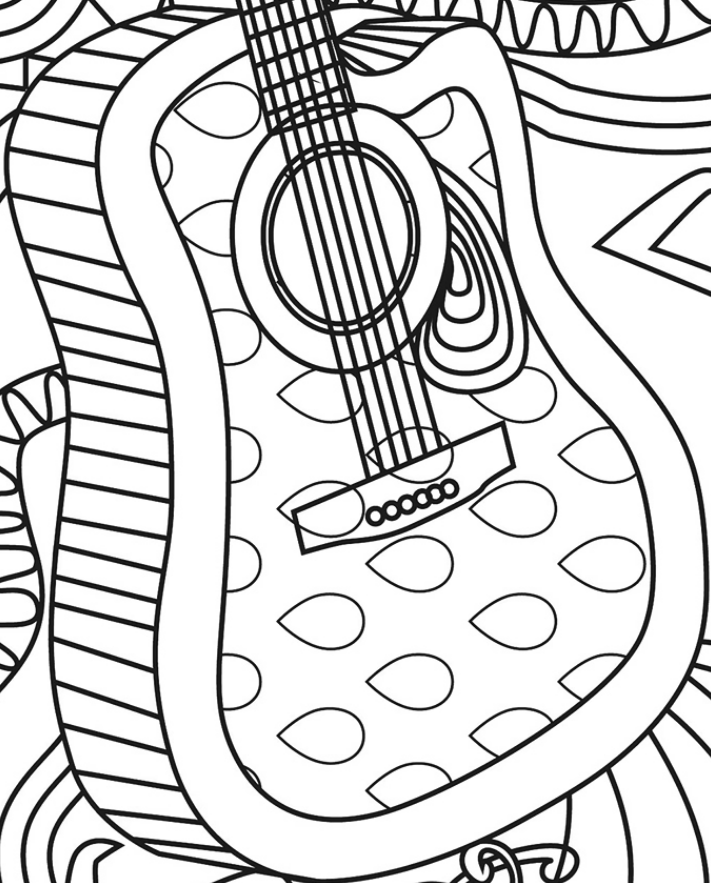
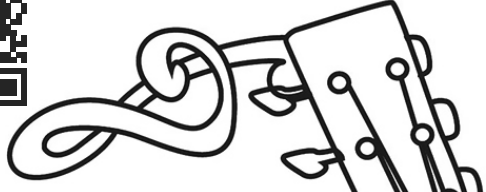

MAKEMUSICDAY.ORG/NZ